

INSTRUCTION MANUAL

Metal Shear

JS3201

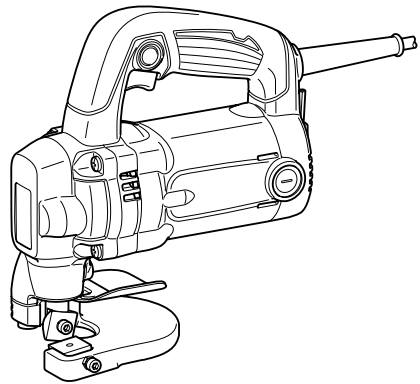

013362

 DOUBLE INSULATION

IMPORTANT: Read Before Using.

ENGLISH (Original instructions)

SPECIFICATIONS

Model		JS3201
Max. cutting capacities	Steel up to 400 N/mm ²	3.2 mm (10 ga.)
	Steel up to 600 N/mm ²	2.5 mm (13 ga.)
	Steel up to 800 N/mm ²	1.5 mm (17 ga.)
	Aluminum up to 200 N/mm ²	4.0 mm (9 ga.)
Min. cutting radius		50 mm
Strokes per minute (min ⁻¹)		1,600
Overall length		213 mm
Net weight		3.4 kg
Safety class		□/II

- Due to our continuing program of research and development, the specifications herein are subject to change without notice.
- Specifications may differ from country to country.
- Weight according to EPTA-Procedure 01/2003

END201-5

ENG905-1

Symbols

The following show the symbols used for the equipment. Be sure that you understand their meaning before use.



- Read instruction manual.



- DOUBLE INSULATION



- Only for EU countries
Do not dispose of electric equipment together with household waste material!

In observance of European Directive 2002/96/EC on waste electric and electronic equipment and its implementation in accordance with national law, electric equipment that have reached the end of their life must be collected separately and returned to an environmentally compatible recycling facility.

ENE037-1

Intended use

The tool is intended for cutting sheet steel and stainless sheet steel.

ENF002-2

Power supply

The tool should be connected only to a power supply of the same voltage as indicated on the nameplate, and can only be operated on single-phase AC supply. They are double-insulated and can, therefore, also be used from sockets without earth wire.

Noise

The typical A-weighted noise level determined according to EN60745:

Sound pressure level (L_{pA}) : 81 dB(A)
Sound power level (L_{WA}) : 92 dB(A)
Uncertainty (K) : 3 dB(A)

Wear ear protection

ENG900-1

Vibration

The vibration total value (tri-axial vector sum) determined according to EN60745:

Work mode : cutting sheet metal
Vibration emission (a_h) : 17.0 m/s²
Uncertainty (K) : 1.5 m/s²

ENG901-1

- The declared vibration emission value has been measured in accordance with the standard test method and may be used for comparing one tool with another.
- The declared vibration emission value may also be used in a preliminary assessment of exposure.

⚠WARNING:

- The vibration emission during actual use of the power tool can differ from the declared emission value depending on the ways in which the tool is used.
- Be sure to identify safety measures to protect the operator that are based on an estimation of exposure in the actual conditions of use (taking account of all parts of the operating cycle such as the times when the tool is switched off and when it is running idle in addition to the trigger time).

For European countries only

EC Declaration of Conformity

We Makita Corporation as the responsible manufacturer declare that the following Makita machine(s):

Designation of Machine:

Metal Shear

Model No./ Type: JS3201

are of series production and

Conforms to the following European Directives:

2006/42/EC

And are manufactured in accordance with the following standards or standardised documents:

EN60745

The technical documentation is kept by:

Makita International Europe Ltd.

Technical Department,

Michigan Drive, Tongwell,

Milton Keynes, Bucks MK15 8JD, England

17.5.2012



Tomoyasu Kato

Director

Makita Corporation

3-11-8, Sumiyoshi-cho,

Anjo, Aichi, 446-8502, JAPAN

000230

GEA005-3

General Power Tool Safety Warnings

⚠ WARNING Read all safety warnings and all instructions. Failure to follow the warnings and instructions may result in electric shock, fire and/or serious injury.

Save all warnings and instructions for future reference.

The term "power tool" in the warnings refers to your mains-operated (corded) power tool or battery-operated (cordless) power tool.

Work area safety

- Keep work area clean and well lit.** Cluttered or dark areas invite accidents.
- Do not operate power tools in explosive atmospheres, such as in the presence of flammable liquids, gases or dust.** Power tools create sparks which may ignite the dust or fumes.
- Keep children and bystanders away while operating a power tool.** Distractions can cause you to lose control.

Electrical safety

- Power tool plugs must match the outlet. Never modify the plug in any way. Do not use any adapter plugs with earthed (grounded) power tools.** Unmodified plugs and matching outlets will reduce risk of electric shock.
- Avoid body contact with earthed or grounded surfaces such as pipes, radiators, ranges and refrigerators.** There is an increased risk of electric shock if your body is earthed or grounded.
- Do not expose power tools to rain or wet conditions.** Water entering a power tool will increase the risk of electric shock.
- Do not abuse the cord. Never use the cord for carrying, pulling or unplugging the power tool. Keep cord away from heat, oil, sharp edges or moving parts.** Damaged or entangled cords increase the risk of electric shock.
- When operating a power tool outdoors, use an extension cord suitable for outdoor use.** Use of a cord suitable for outdoor use reduces the risk of electric shock.
- If operating a power tool in a damp location is unavoidable, use a residual current device (RCD) protected supply.** Use of an RCD reduces the risk of electric shock.
- Use of power supply via a RCD with a rated residual current of 30mA or less is always recommended.**

Personal safety

- Stay alert, watch what you are doing and use common sense when operating a power tool. Do not use a power tool while you are tired or under the influence of drugs, alcohol or medication.** A moment of inattention while operating power tools may result in serious personal injury.
- Use personal protective equipment. Always wear eye protection.** Protective equipment such as dust mask, non-skid safety shoes, hard hat, or hearing protection used for appropriate conditions will reduce personal injuries.
- Prevent unintentional starting. Ensure the switch is in the off-position before connecting to power source and/or battery pack, picking up or carrying the tool.** Carrying power tools with your finger on the switch or energising power tools that have the switch on invites accidents.
- Remove any adjusting key or wrench before turning the power tool on.** A wrench or a key left attached to a rotating part of the power tool may result in personal injury.

15. **Do not overreach. Keep proper footing and balance at all times.** This enables better control of the power tool in unexpected situations.
16. **Dress properly. Do not wear loose clothing or jewellery. Keep your hair, clothing, and gloves away from moving parts.** Loose clothes, jewellery or long hair can be caught in moving parts.
17. **If devices are provided for the connection of dust extraction and collection facilities, ensure these are connected and properly used.** Use of dust collection can reduce dust-related hazards.

Power tool use and care

18. **Do not force the power tool. Use the correct power tool for your application.** The correct power tool will do the job better and safer at the rate for which it was designed.
19. **Do not use the power tool if the switch does not turn it on and off.** Any power tool that cannot be controlled with the switch is dangerous and must be repaired.
20. **Disconnect the plug from the power source and/or the battery pack from the power tool before making any adjustments, changing accessories, or storing power tools.** Such preventive safety measures reduce the risk of starting the power tool accidentally.
21. **Store idle power tools out of the reach of children and do not allow persons unfamiliar with the power tool or these instructions to operate the power tool.** Power tools are dangerous in the hands of untrained users.
22. **Maintain power tools. Check for misalignment or binding of moving parts, breakage of parts and any other condition that may affect the power tool's operation. If damaged, have the power tool repaired before use.** Many accidents are caused by poorly maintained power tools.
23. **Keep cutting tools sharp and clean.** Properly maintained cutting tools with sharp cutting edges are less likely to bind and are easier to control.
24. **Use the power tool, accessories and tool bits etc. in accordance with these instructions, taking into account the working conditions and the work to be performed.** Use of the power tool for operations different from those intended could result in a hazardous situation.

Service

25. **Have your power tool serviced by a qualified repair person using only identical replacement parts.** This will ensure that the safety of the power tool is maintained.
26. **Follow instruction for lubricating and changing accessories.**
27. **Keep handles dry, clean and free from oil and grease.**

GEB027-3

SHEAR SAFETY WARNINGS

1. **Hold the tool firmly.**
2. **Secure the workpiece firmly.**
3. **Keep hands away from moving parts.**
4. **Edges and chips of the workpiece are sharp. Wear gloves. It is also recommended that you put on thickly bottomed shoes to prevent injury.**
5. **Do not put the tool on the chips of the workpiece. Otherwise it can cause damage and trouble on the tool.**
6. **Do not leave the tool running. Operate the tool only when hand-held.**
7. **Always be sure you have a firm footing. Be sure no one is below when using the tool in high locations.**
8. **Do not touch the blade or the workpiece immediately after operation; they may be extremely hot and could burn your skin.**
9. **Avoid cutting electrical wires. It can cause serious accident by electric shock.**
10. **Do not operate the tool at no-load unnecessarily.**

SAVE THESE INSTRUCTIONS.

⚠WARNING:

DO NOT let comfort or familiarity with product (gained from repeated use) replace strict adherence to safety rules for the subject product. MISUSE or failure to follow the safety rules stated in this instruction manual may cause serious personal injury.

FUNCTIONAL DESCRIPTION

⚠ CAUTION:

- Always be sure that the tool is switched off and unplugged before adjusting or checking function on the tool.

Switch action

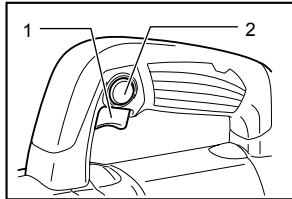

013363

1. Switch trigger
2. Lock button

⚠ CAUTION:

- Before plugging in the tool, always check to see that the switch trigger actuates properly and returns to the "OFF" position when released.
- Switch can be locked in "ON" position for ease of operator comfort during extended use. Apply caution when locking tool in "ON" position and maintain firm grasp on tool.

To start the tool, simply pull the switch trigger. Release the switch trigger to stop.

For continuous operation, pull the switch trigger and then push in the lock button.

To stop the tool from the locked position, pull the switch trigger fully, then release it.

Permissible shearing thickness

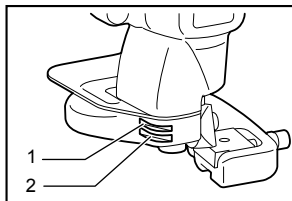

013364

The groove on the yoke serves as a thickness gauge for shearing mild or stainless steel plate. If the material fits within the groove, it is shearable.

The thickness of materials to be sheared depends upon the type (strength) of the material. The maximum shearing thickness is indicated in the table below in terms of various materials. Attempting to shear materials thicker than indicated will result in tool breakdown and/or possible injury. Keep within the thickness shown in the table.

1. Gauge for stainless: 2.5 mm (3/32")
2. Gauge for mild steel: 3.2 mm (1/8")

Max. cutting capacities	mm	ga
Steel up to 400 N/mm ²	3.2	10
Steel up to 600 N/mm ²	2.5	13
Steel up to 800 N/mm ²	1.5	17
Aluminum up to 200 N/mm ²	4.0	9

006426

ASSEMBLY

⚠ CAUTION:

- Always be sure that the tool is switched off and unplugged before carrying out any work on the tool.

Blade inspection

Before using the tool, check the blades for wear. Dull, worn blades will result in poor shearing action, and the service life of the tool will be shortened.

The service life of the blades varies in terms of the materials to be cut and the fixed blade clearance. Roughly speaking, a blade can cut about 500 m of 3.2 mm mild steel with one cutting edge (total 2,000 m with four cutting edges).

Rotating or replacing blades

Both the upper and lower blades have four cutting edges on each side (the front and back). When the cutting edge becomes dull, rotate both the upper and the lower blades 90° to expose new cutting edges.

When all eight edges are dull on both the upper and lower blades, replace both blades with new ones. Each time blades are rotated or replaced, proceed as follows.

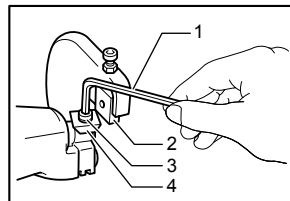

004679

Remove the blade securing bolts with the hex wrench provided and then rotate or replace the blades.

1. Hex wrench
2. Lower blade
3. Upper blade securing bolt
4. Upper blade

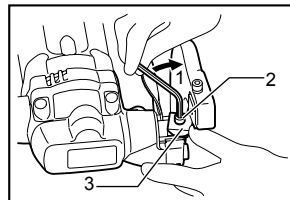

013365

Install the upper blade and tighten the upper blade securing bolt with the hex wrench. Press up on the upper blade while tightening it.

1. Tighten
2. Upper blade securing bolt
3. Upper blade

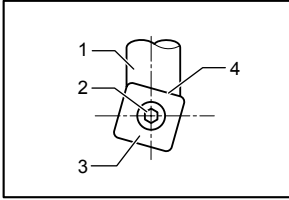

1. Blade holder
2. Upper blade securing bolt
3. Upper blade
4. No gap allowed

004683

After securing the upper blade, be sure that there is no gap left between the upper blade and the beveled surface of the blade holder.

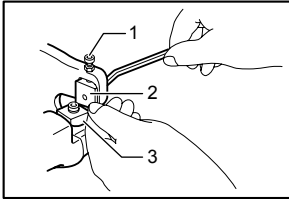

1. Lower blade positioning bolt
2. Lower blade
3. Upper blade

004684

Then install the lower blade like the upper blade while adjusting the clearance between the upper blade and lower blades. When performing this adjustment, the upper blade should be in the lowered position.

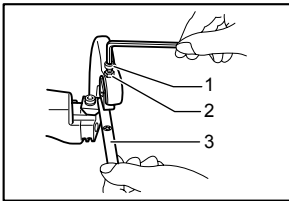

1. Lower blade positioning bolt
2. Hex nut
3. Thickness gauge

004685

First, semi-tighten the lower blade securing bolt, then insert the thickness gauge for the desired clearance. The cutting thickness is indicated on the thickness gauge so the combinations shown in the table below should be used. Work the lower blade positioning bolt on the yoke until the clearance is such that the thickness gauge moves only with some difficulty. Then firmly tighten the lower blade securing bolt. Finally, tighten the hex nut to secure the lower blade positioning bolt.

Thickness gauge combinations

Material thickness	2.3 mm (14 ga.)	2.5 mm (13 ga.)	3.2 mm (10 ga.)
Thickness gauge combinations	1.0 +1.5	1.0 +1.5	1.5 + 2.0

006427

OPERATION

⚠CAUTION:

- When cutting, always place the shear on the workpiece so that the material cut away is positioned on the right side to the operator.
- Hold the tool firmly with one hand on the main handle when performing the tool.

Holding material

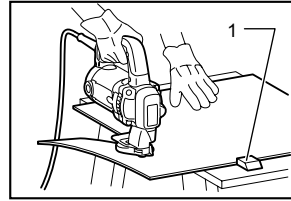

1. Workholder

013366

The materials for cutting should be fastened to the workbench by means of workholders.

Shearing method

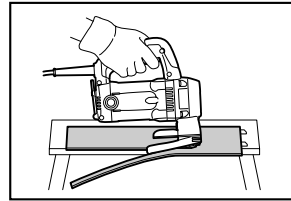

013367

For smooth cuts, tip the tool slightly backward while advancing it.

Maximum cutting width

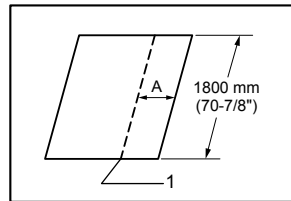

1. Cutting line

004703

Stay within the specified maximum cutting width (A):
Case of length 1,800 mm.

Mild steel (thickness)	3.2 mm	Under 2.3 mm
Max. cutting width (A)	90 mm	No limit

Stainless (thickness)	2.5 mm	Under 2.0 mm
Max. cutting width (A)	70 mm	No limit

006432

Minimum cutting radius

Minimum cutting radius is 50 mm when cutting 2.3 mm mild steel.

MAINTENANCE

⚠CAUTION:

- Always be sure that the tool is switched off and unplugged before attempting to perform inspection or maintenance.
- Never use gasoline, benzine, thinner, alcohol or the like. Discoloration, deformation or cracks may result.

The tool and its air vents have to be kept clean. Regularly clean the tool's air vents or whenever the vents start to become obstructed.

Replacing carbon brushes

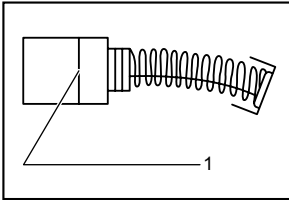

1. Limit mark

001145

Remove and check the carbon brushes regularly. Replace when they wear down to the limit mark. Keep the carbon brushes clean and free to slip in the holders. Both carbon brushes should be replaced at the same time. Use only identical carbon brushes.

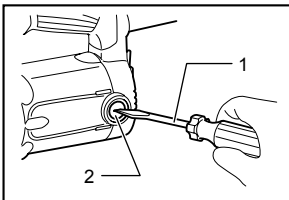

1. Screwdriver
2. Brush holder cap

013361

Use a screwdriver to remove the brush holder caps. Take out the worn carbon brushes, insert the new ones and secure the brush holder caps.

To maintain product SAFETY and RELIABILITY, repairs, any other maintenance or adjustment should be performed by Makita Authorized Service Centers, always using Makita replacement parts.

OPTIONAL ACCESSORIES

⚠CAUTION:

- These accessories or attachments are recommended for use with your Makita tool specified in this manual. The use of any other accessories or attachments might present a risk of injury to persons. Only use accessory or attachment for its stated purpose.

If you need any assistance for more details regarding these accessories, ask your local Makita Service Center.

- Blades
- Hex wrench
- Thickness gauge

NOTE:

- Some items in the list may be included in the tool package as standard accessories. They may differ from country to country.

Makita Corporation
Anjo, Aichi, Japan

885171-228

www.makita.com