

## INSTRUCTION MANUAL

# Cutter

4100NH3

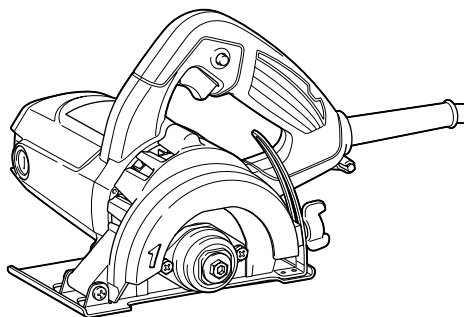

013765



DOUBLE INSULATION

**IMPORTANT:** Read Before Using.

## ENGLISH (Original instructions)

# SPECIFICATIONS

Model	4100NH3
Blade diameter	110 mm
Hole diameter	20 mm
Max. diamond wheel thickness	2.0 mm
Max. cutting capacity	32 mm
Rated speed (n) / No load speed (n <sub>0</sub> )	13,000 min <sup>-1</sup>
Overall length	227 mm
Net weight	2.9 kg
Safety class	II/III

- Due to our continuing program of research and development, the specifications herein are subject to change without notice.
- Specifications may differ from country to country.
- Weight according to EPTA-Procedure 01/2003

END202-8

GEA005-3

## Symbols

The following show the symbols used for the equipment. Be sure that you understand their meaning before use.



- Read instruction manual.



- DOUBLE INSULATION



- Wear safety glasses.



- Only for EU countries

Do not dispose of electric equipment together with household waste material!

In observance of the European Directive, on Waste Electric and Electronic Equipment and its implementation in accordance with national law, electric equipment that have reached the end of their life must be collected separately and returned to an environmentally compatible recycling facility.

ENE024-1

## Intended use

The tool is intended for cutting in brick and concrete without the use of water.

ENF002-2

## Power supply

The tool should be connected only to a power supply of the same voltage as indicated on the nameplate, and can only be operated on single-phase AC supply. They are double-insulated and can, therefore, also be used from sockets without earth wire.

## General Power Tool Safety Warnings

**⚠ WARNING** Read all safety warnings and all instructions. Failure to follow the warnings and instructions may result in electric shock, fire and/or serious injury.

## Save all warnings and instructions for future reference.

The term "power tool" in the warnings refers to your mains-operated (corded) power tool or battery-operated (cordless) power tool.

### Work area safety

1. **Keep work area clean and well lit.** Cluttered or dark areas invite accidents.
2. **Do not operate power tools in explosive atmospheres, such as in the presence of flammable liquids, gases or dust.** Power tools create sparks which may ignite the dust or fumes.
3. **Keep children and bystanders away while operating a power tool.** Distractions can cause you to lose control.

### Electrical safety

4. **Power tool plugs must match the outlet. Never modify the plug in any way. Do not use any adapter plugs with earthed (grounded) power tools.** Unmodified plugs and matching outlets will reduce risk of electric shock.
5. **Avoid body contact with earthed or grounded surfaces such as pipes, radiators, ranges and refrigerators.** There is an increased risk of electric shock if your body is earthed or grounded.
6. **Do not expose power tools to rain or wet conditions.** Water entering a power tool will increase the risk of electric shock.

7. **Do not abuse the cord. Never use the cord for carrying, pulling or unplugging the power tool. Keep cord away from heat, oil, sharp edges or moving parts.** Damaged or entangled cords increase the risk of electric shock.
8. **When operating a power tool outdoors, use an extension cord suitable for outdoor use.** Use of a cord suitable for outdoor use reduces the risk of electric shock.
9. **If operating a power tool in a damp location is unavoidable, use a residual current device (RCD) protected supply.** Use of an RCD reduces the risk of electric shock.
10. **Use of power supply via a RCD with a rated residual current of 30 mA or less is always recommended.**
19. **Do not use the power tool if the switch does not turn it on and off.** Any power tool that cannot be controlled with the switch is dangerous and must be repaired.
20. **Disconnect the plug from the power source and/or the battery pack from the power tool before making any adjustments, changing accessories, or storing power tools.** Such preventive safety measures reduce the risk of starting the power tool accidentally.

#### Personal safety

11. **Stay alert, watch what you are doing and use common sense when operating a power tool. Do not use a power tool while you are tired or under the influence of drugs, alcohol or medication.** A moment of inattention while operating power tools may result in serious personal injury.
12. **Use personal protective equipment. Always wear eye protection.** Protective equipment such as dust mask, non-skid safety shoes, hard hat, or hearing protection used for appropriate conditions will reduce personal injuries.
13. **Prevent unintentional starting. Ensure the switch is in the off-position before connecting to power source and/or battery pack, picking up or carrying the tool.** Carrying power tools with your finger on the switch or energising power tools that have the switch on invites accidents.
14. **Remove any adjusting key or wrench before turning the power tool on.** A wrench or a key left attached to a rotating part of the power tool may result in personal injury.
15. **Do not overreach. Keep proper footing and balance at all times.** This enables better control of the power tool in unexpected situations.
16. **Dress properly. Do not wear loose clothing or jewellery. Keep your hair, clothing, and gloves away from moving parts.** Loose clothes, jewellery or long hair can be caught in moving parts.
17. **If devices are provided for the connection of dust extraction and collection facilities, ensure these are connected and properly used.** Use of dust collection can reduce dust-related hazards.
21. **Store idle power tools out of the reach of children and do not allow persons unfamiliar with the power tool or these instructions to operate the power tool.** Power tools are dangerous in the hands of untrained users.
22. **Maintain power tools. Check for misalignment or binding of moving parts, breakage of parts and any other condition that may affect the power tool's operation. If damaged, have the power tool repaired before use.** Many accidents are caused by poorly maintained power tools.
23. **Keep cutting tools sharp and clean.** Properly maintained cutting tools with sharp cutting edges are less likely to bind and are easier to control.
24. **Use the power tool, accessories and tool bits etc. in accordance with these instructions, taking into account the working conditions and the work to be performed.** Use of the power tool for operations different from those intended could result in a hazardous situation.

#### Service

25. **Have your power tool serviced by a qualified repair person using only identical replacement parts.** This will ensure that the safety of the power tool is maintained.
26. **Follow instruction for lubricating and changing accessories.**
27. **Keep handles dry, clean and free from oil and grease.**

GEB069-6

## CUTTER SAFETY WARNINGS

1. **The guard provided with the tool must be securely attached to the power tool and positioned for maximum safety, so the least amount of wheel is exposed towards the operator. Position yourself and bystanders away from the plane of the rotating wheel.** The guard helps to protect operator from broken wheel fragments and accidental contact with wheel.
2. **Use only diamond cut-off wheels for your power tool.** Just because an accessory can be attached to your power tool, it does not assure safe operation.

#### Power tool use and care

18. **Do not force the power tool. Use the correct power tool for your application.** The correct power tool will do the job better and safer at the rate for which it was designed.

3. **The rated speed of the accessory must be at least equal to the maximum speed marked on the power tool.** Accessories running faster than their rated speed can break and fly apart.
  4. **Wheels must be used only for recommended applications. For example: do not grind with the side of cut-off wheel.** Abrasive cut-off wheels are intended for peripheral grinding, side forces applied to these wheels may cause them to shatter.
  5. **Always use undamaged wheel flanges that are of correct diameter for your selected wheel.** Proper wheel flanges support the wheel thus reducing the possibility of wheel breakage.
  6. **The outside diameter and the thickness of your accessory must be within the capacity rating of your power tool.** Incorrectly sized accessories cannot be adequately guarded or controlled.
  7. **The arbour size of wheels and flanges must properly fit the spindle of the power tool.** Wheels and flanges with arbour holes that do not match the mounting hardware of the power tool will run out of balance, vibrate excessively and may cause loss of control.
  8. **Do not use damaged wheels. Before each use, inspect the wheels for chips and cracks. If power tool or wheel is dropped, inspect for damage or install an undamaged wheel. After inspecting and installing the wheel, position yourself and bystanders away from the plane of the rotating wheel and run the power tool at maximum no load speed for one minute.** Damaged wheels will normally break apart during this test time.
  9. **Wear personal protective equipment. Depending on application, use face shield, safety goggles or safety glasses. As appropriate, wear dust mask, hearing protectors, gloves and shop apron capable of stopping small abrasive or workpiece fragments.** The eye protection must be capable of stopping flying debris generated by various operations. The dust mask or respirator must be capable of filtrating particles generated by your operation. Prolonged exposure to high intensity noise may cause hearing loss.
  10. **Keep bystanders a safe distance away from work area. Anyone entering the work area must wear personal protective equipment.** Fragments of workpiece or of a broken wheel may fly away and cause injury beyond immediate area of operation.
  11. **Hold the power tool by insulated gripping surfaces only, when performing an operation where the cutting accessory may contact hidden wiring or its own cord.** Cutting accessory contacting a "live" wire may make exposed metal parts of the power tool "live" and could give the operator an electric shock.
  12. **Position the cord clear of the spinning accessory.** If you lose control, the cord may be cut or snagged and your hand or arm may be pulled into the spinning wheel.
  13. **Never lay the power tool down until the accessory has come to a complete stop.** The spinning wheel may grab the surface and pull the power tool out of your control.
  14. **Do not run the power tool while carrying it at your side.** Accidental contact with the spinning accessory could snag your clothing, pulling the accessory into your body.
  15. **Regularly clean the power tool's air vents.** The motor's fan will draw the dust inside the housing and excessive accumulation of powdered metal may cause electrical hazards.
  16. **Do not operate the power tool near flammable materials.** Sparks could ignite these materials.
  17. **Do not use accessories that require liquid coolants.** Using water or other liquid coolants may result in electrocution or shock.
- Kickback and related warnings**
- Kickback is a sudden reaction to a pinched or snagged rotating wheel. Pinching or snagging causes rapid stalling of the rotating wheel which in turn causes the uncontrolled power tool to be forced in the direction opposite of the wheel's rotation at the point of the binding.
- For example, if an abrasive wheel is snagged or pinched by the workpiece, the edge of the wheel that is entering into the pinch point can dig into the surface of the material causing the wheel to climb out or kick out. The wheel may either jump toward or away from the operator, depending on direction of the wheel's movement at the point of pinching. Abrasive wheels may also break under these conditions.
- Kickback is the result of power tool misuse and/or incorrect operating procedures or conditions and can be avoided by taking proper precautions as given below.
- a) **Maintain a firm grip on the power tool and position your body and arm to allow you to resist kickback forces. Always use auxiliary handle, if provided, for maximum control over kickback or torque reaction during start-up.** The operator can control torque reactions or kickback forces, if proper precautions are taken.
  - b) **Never place your hand near the rotating accessory.** Accessory may kickback over your hand.
  - c) **Do not position your body in line with the rotating wheel.** Kickback will propel the tool in direction opposite to the wheel's movement at the point of snagging.
  - d) **Use special care when working corners, sharp edges etc. Avoid bouncing and snagging the accessory.** Corners, sharp edges or bouncing have a tendency to snag the rotating accessory and cause loss of control or kickback.

e) Do not attach a saw chain, woodcarving blade, segmented diamond wheel with a peripheral gap greater than 10 mm or toothed saw blade. Such blades create frequent kickback and loss of control.

f) Do not “jam” the wheel or apply excessive pressure. Do not attempt to make an excessive depth of cut. Overstressing the wheel increases the loading and susceptibility to twisting or binding of the wheel in the cut and the possibility of kickback or wheel breakage.

g) When wheel is binding or when interrupting a cut for any reason, switch off the power tool and hold the power tool motionless until the wheel comes to a complete stop. Never attempt to remove the wheel from the cut while the wheel is in motion otherwise kickback may occur. Investigate and take corrective action to eliminate the cause of wheel binding.

h) Do not restart the cutting operation in the workpiece. Let the wheel reach full speed and carefully re-enter the cut. The wheel may bind, walk up or kickback if the power tool is restarted in the workpiece.

i) Support panels or any oversized workpiece to minimize the risk of wheel pinching and kickback. Large workpieces tend to sag under their own weight. Supports must be placed under the workpiece near the line of cut and near the edge of the workpiece on both sides of the wheel.

j) Use extra caution when making a “pocket cut” into existing walls or other blind areas. The protruding wheel may cut gas or water pipes, electrical wiring or objects that can cause kickback.

18. Before using a segmented diamond wheel, make sure that the diamond wheel has the peripheral gap between segments of 10 mm or less, only with a negative rake angle.

#### Additional Safety Warnings:

19. Never attempt to cut with the tool held upside down in a vise. This can lead to serious accidents, because it is extremely dangerous.
20. Some material contains chemicals which may be toxic. Take caution to prevent dust inhalation and skin contact. Follow material supplier safety data.
21. Store wheels as per manufacturer recommendations. Improper storage may damage the wheels.

## SAVE THESE INSTRUCTIONS.

### ⚠WARNING:

DO NOT let comfort or familiarity with product (gained from repeated use) replace strict adherence to safety rules for the subject product. MISUSE or failure to follow the safety rules stated in this instruction manual may cause serious personal injury.

## FUNCTIONAL DESCRIPTION

### ⚠CAUTION:

- Always be sure that the tool is switched off and unplugged before adjusting or checking function on the tool.

### Adjusting the depth of cut

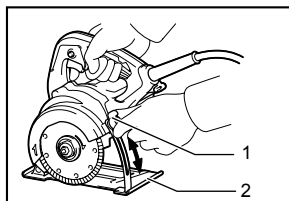

1. Wing bolt
2. Base

013769

Loosen the wing bolt on the depth guide and move the base up or down. At the desired depth of cut, secure the base by tightening the wing bolt.

### ⚠CAUTION:

- After adjusting depth of cut, always tighten the wing bolt securely.

### Sighting

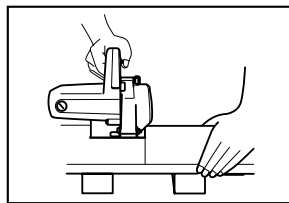

001674

Align the edge of the front of the base with your cutting line on the workpiece.

### Switch action

### ⚠CAUTION:

- Before plugging in the tool, always check to see that the switch trigger actuates properly and returns to the “OFF” position when released.

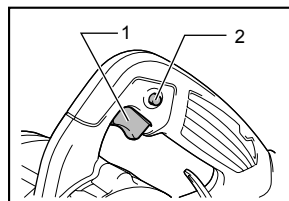

1. Switch trigger
2. Lock button / Lock-off button

013740

### For tool with lock button

To start the tool, simply pull the switch trigger. Release the switch trigger to stop. For continuous operation, pull the switch trigger, push in the lock button and then release the switch trigger. To stop the tool from the locked position, pull the trigger fully, then release it.

### For tool with lock-off button

To prevent the switch trigger from being accidentally pulled, a lock-off button is provided.

To start the tool, depress the lock-off button and pull the switch trigger. Release the switch trigger to stop.

#### ⚠CAUTION:

- Do not pull the switch trigger hard without pressing in the lock-off button. This can cause switch breakage.

### For tool without lock button / lock-off button

To start the tool, simply pull the switch trigger. Release the switch trigger to stop.

## ASSEMBLY

#### ⚠CAUTION:

- Always be sure that the tool is switched off and unplugged before carrying out any work on the tool.

### Removing or installing diamond wheel (optional accessory)

#### ⚠CAUTION:

- Always be sure that the tool is switched off and unplugged before installing or removing the diamond wheel.
- Use only the Makita wrench to install or remove the diamond wheel.

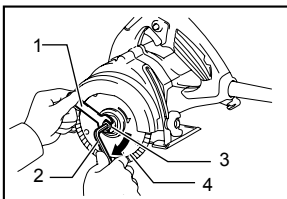

1. Wrench
2. Hex wrench
3. Outer flange
4. Diamond wheel

013766

To remove the diamond wheel, hold the outer flange with the wrench and loosen the hex bolt clockwise with the hex wrench. Then remove the hex bolt, outer flange and diamond wheel.

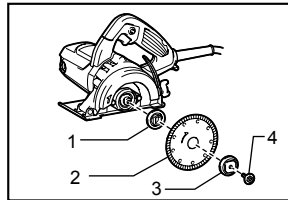

1. Inner flange
2. Diamond wheel
3. Outer flange
4. Hex bolt

013767

To install the diamond wheel, follow the removal procedure in reverse. Always install the diamond wheel so that the arrow on the diamond wheel points in the same direction as the arrow on the blade case. **BE SURE TO TIGHTEN THE HEX BOLT COUNTERCLOCKWISE SECURELY.**

### Hex wrench storage

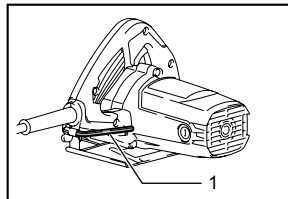

1. Hex wrench

013768

When not in use, store the hex wrench as shown in the figure to keep it from being lost.

## OPERATION

#### ⚠CAUTION:

- This tool should only be used on horizontal surfaces.
- Be sure to move the tool forward in a straight line and gently. Forcing and exerting excessive pressure or allowing the diamond wheel to bend, pinch or twist in the cut can cause overheating of the motor and dangerous kickback of the tool.

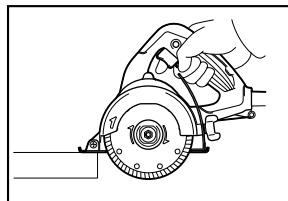

013770

Hold the tool firmly. Set the base plate on the workpiece to be cut without the diamond wheel making any contact. Then turn the tool on and wait until the diamond wheel attains full speed.

Now simply move the tool forward over the workpiece surface, keeping it flat and advancing smoothly until the cutting is completed. Keep your cutting line straight and your speed of advance uniform.

## MAINTENANCE

### ⚠CAUTION:

- Always be sure that the tool is switched off and unplugged before attempting to perform inspection or maintenance.
- Never use gasoline, benzine, thinner, alcohol or the like. Discoloration, deformation or cracks may result.

### After use

Blow away dust from the inside of the tool by running the tool at an idle for a while. Brush off accumulation of dust on the base. Accumulation of dust in the motor or on the base may cause a malfunction of the tool.

### Replacing carbon brushes

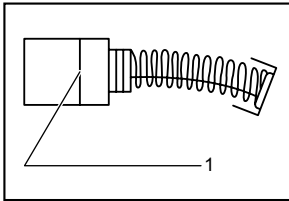

1. Limit mark

001145

Remove and check the carbon brushes regularly. Replace when they wear down to the limit mark. Keep the carbon brushes clean and free to slip in the holders. Both carbon brushes should be replaced at the same time. Use only identical carbon brushes.

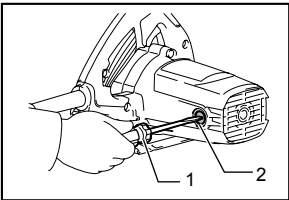

1. Screwdriver  
2. Brush holder cap

013742

Use a screwdriver to remove the brush holder caps. Take out the worn carbon brushes, insert the new ones and secure the brush holder caps.

To maintain product SAFETY and RELIABILITY, repairs, any other maintenance or adjustment should be performed by Makita Authorized Service Centers, always using Makita replacement parts.

## OPTIONAL ACCESSORIES

### ⚠CAUTION:

- These accessories or attachments are recommended for use with your Makita tool specified in this manual. The use of any other accessories or attachments might present a risk of injury to persons. Only use accessory or attachment for its stated purpose.

If you need any assistance for more details regarding these accessories, ask your local Makita Service Center.

- Diamond wheels (Dry type)
- Wrench 22
- Hex wrench

### NOTE:

- Some items in the list may be included in the tool package as standard accessories. They may differ from country to country.

**Makita Corporation**  
Anjo, Aichi, Japan

885205-924

[www.makita.com](http://www.makita.com)